









-  PRESSURE RELIEF VALVE
-  PRESSURE REGULATOR
-  PRESSURE GAUGE
-  ISOLATION VALVE
-  NON RETURN VALVE
-  FLEXIBLE LEADS
-  PRESSURE SWITCH
-  3 WAY VALVE







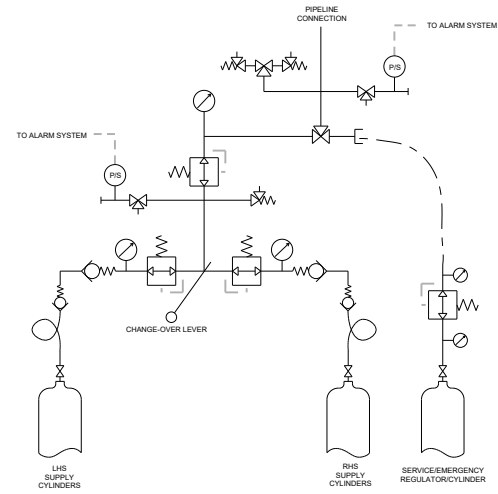
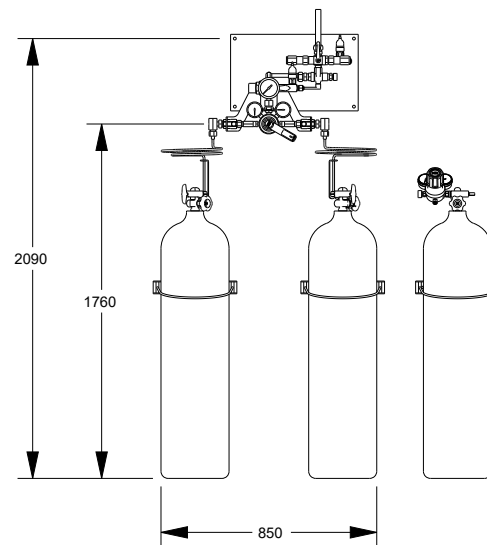



**SCHEMATIC**

**GASCON SYSTEMS**  
**AS2896 AUTO CHANGE-OVER MANIFOLDS**  
 1x1, 1 CYLINDER PER SIDE  
 MODELS: MM120, MM500, MM500TT  
 MM800, MM800TT



**PHYSICAL**

-  PRESSURE RELIEF VALVE
-  PRESSURE REGULATOR
-  PRESSURE GAUGE
-  ISOLATION VALVE
-  NON RETURN VALVE
-  FLEXIBLE LEADS
-  PRESSURE SWITCH
-  3 WAY VALVE

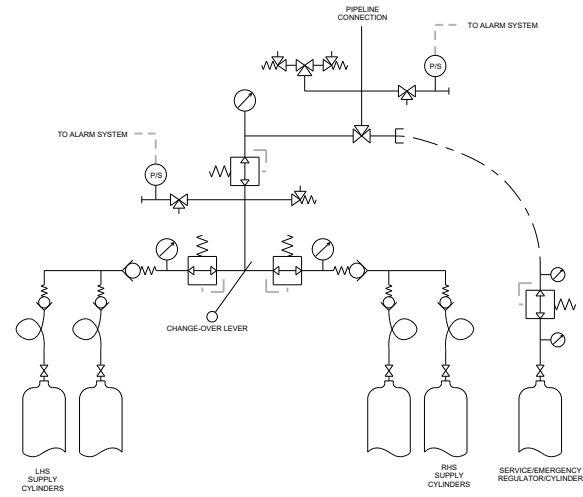





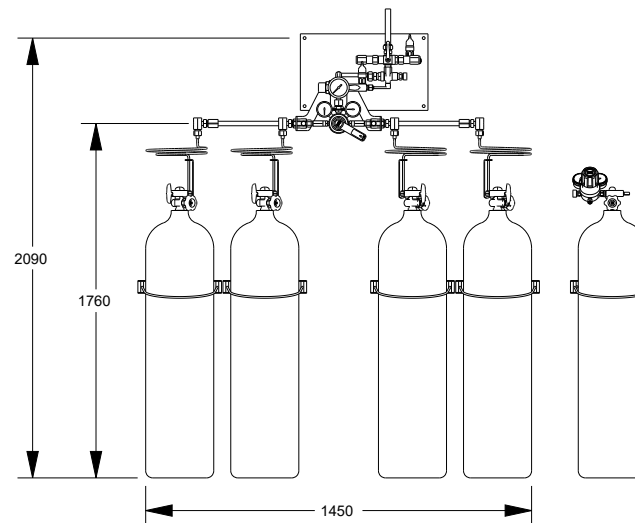



**SCHEMATIC**

**GASCON SYSTEMS**  
**AS2896 AUTO CHANGE-OVER MANIFOLDS**  
 2x2, 2 CYLINDERS PER SIDE  
 MODELS: MM120, MM500, MM500TT  
 MM800, MM800TT



**PHYSICAL**

-  PRESSURE RELIEF VALVE
-  PRESSURE REGULATOR
-  PRESSURE GAUGE
-  ISOLATION VALVE
-  NON RETURN VALVE
-  FLEXIBLE LEADS
-  PRESSURE SWITCH
-  3 WAY VALVE

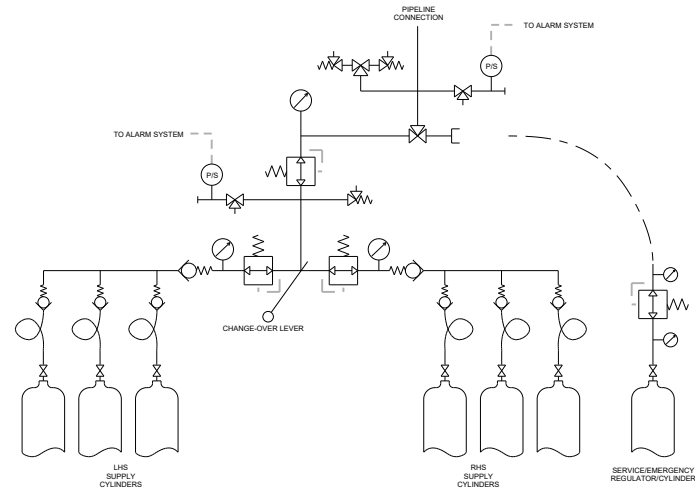





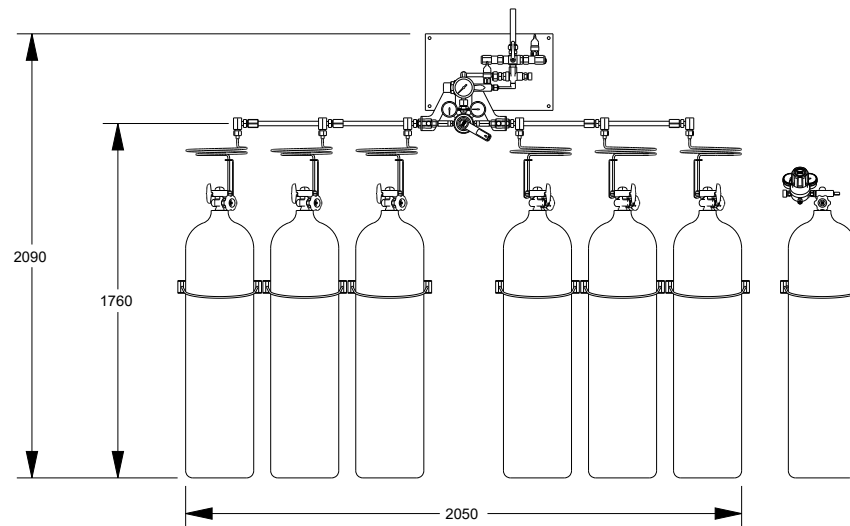



**SCHEMATIC**

**GASCON SYSTEMS**  
**AS2896 AUTO CHANGE-OVER MANIFOLDS**  
 3x3, 3 CYLINDERS PER SIDE  
 MODELS: MM120, MM500, MM500TT  
 MM800, MM800TT



**PHYSICAL**

-  PRESSURE RELIEF VALVE
-  PRESSURE REGULATOR
-  PRESSURE GAUGE
-  ISOLATION VALVE
-  NON RETURN VALVE
-  FLEXIBLE LEADS
-  PRESSURE SWITCH
-  3 WAY VALVE

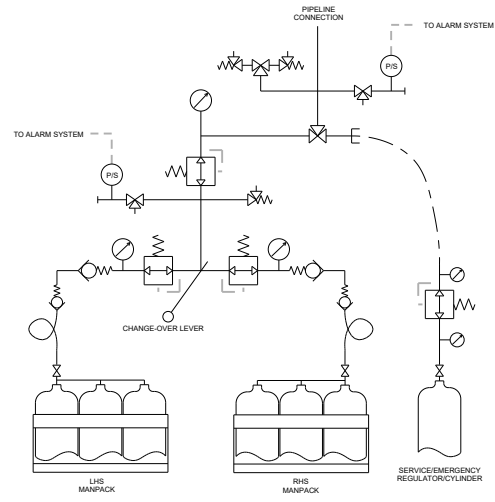

SCHMATIC

GASCON SYSTEMS  
 AS2896 AUTO CHANGE-OVER MANIFOLDS  
 PxP, 1 MANPACK PER SIDE  
 MODELS: MM120, MM500, MM500TT  
 MM800, MM800TT

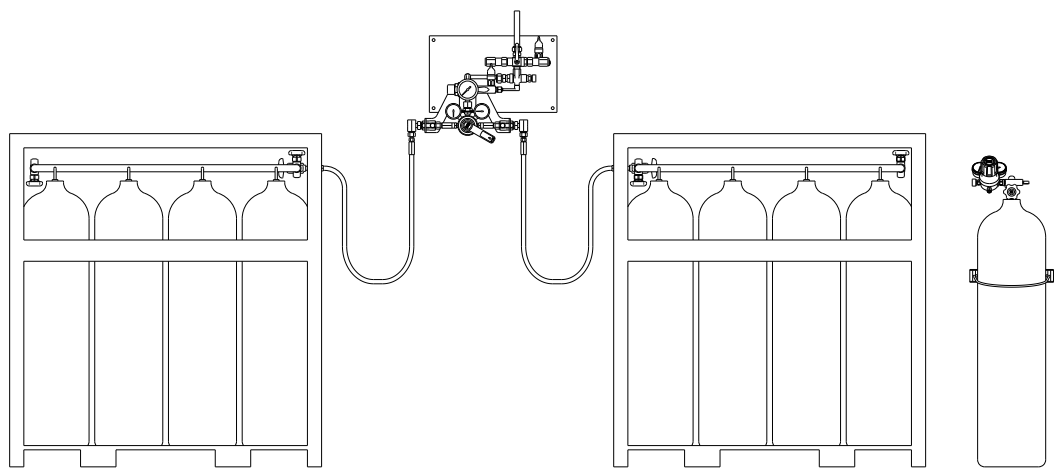

PHYSICAL